

# Dynamic Modeling And Simulation Of The Synchronous Generator

*By Sugiarto -*

# DYNAMIC MODELING AND SIMULATION OF THE SYNCHRONOUS GENERATOR

13 Sugiarto

Electrical Engineering Department  
Sekolah Tinggi Teknologi Nasional  
Yogyakarta, Indonesia  
sugiarto.kadiman@gmail.com

## Abstract

*In this paper, the modeling and simulation of the synchronous generator are presented by using  $qd0$  reference of frame. The capability of the model to approximate the non-linear operating characteristics of the generator is illustrated. At the beginning, the results of the model are compared with that obtained by PSS Tecquipment NE9070. Finally, similarity-based model validity tests are performed. The all results demonstrate the adequacy of the generator model.*

*Keywords:* synchronous generator,  $qd0$  reference of frame, PSS Tecquipment NE9070

## 1. Introduction

The models of synchronous generators widely employed in various areas play important roles in many studies such as stability and control analysis. Different synchronous generator models have been developed [1], [2], [3], [4]. Simple generator models are good for analysis studies but not accurate enough for predicting generator performance for control studies. However, the higher order models improve the validity of the results.

This paper presents an effective approach of modelling and simulation the large synchronous generator under steady-state operation. This approach allows a user to simulate different kinds of loading operation conditions of the generator easily. In addition, the user can learn GUI (Graphical Unit Interface) capabilities to construct a user-friendly software package for learning the synchronous generator.

In visual software, the synchronous generator blocks are designed to be balanced model and connected to a grid networks. Unfortunately, the user may be difficult to represent the framework of three-phase synchronous generator. It is why three-phase balanced synchronous generator complete model will be presented in this study. The proposed model is based on the electrical circuit of the machine. As a basis for developing an easy-to-use educational software tool, some of GUI functions are implemented in creating an active link with this model. A brief explanation about modeling of the synchronous generator model is defined on Section II. Section III presents the demonstration. Section IV presents the final conclusion obtained with the present study.

## 2. Synchronous Generator Model

For constructing the synchronous generator model (Figure 1), there were the following assumptions:

1. a symmetrical tri-phase stator winding system is assumed,
2. one field winding is considered to be in the machine,
3. there are two amortisseur or damper windings in the machine,
4. all of the windings are magnetically coupled,

5. the flux linkage of the winding is a function of the rotor position,
6. the copper losses and the slots in the machine are neglected,
7. the spatial distribution of the stator fluxes and apertures wave are considered to be sinusoidal,

8. stator and rotor permeability are assumed to be infinite.

It is also assumed that all the losses due to saturation and slots can be neglected.

The six windings are magnetically coupled. Since the magnetic coupling between the windings is a function of the rotor position, the flux linking of the windings is also a function of the rotor position.

The machine equation in three-axes framework can be written as:

$$\begin{aligned} v_{abc} &= -r_s \cdot i_{abc} + \frac{d}{dt} \Psi_{abc} & v_f &= r_f \cdot i_f + \frac{d}{dt} \Psi_f \\ 0 &= r_{kq} \cdot i_{kq} + \frac{d}{dt} \Psi_{kq} & 0 &= r_{kd} \cdot i_{kd} + \frac{d}{dt} \Psi_{kd} \end{aligned} \quad (1)$$

Where  $i_{kd}$  and  $i_{kq}$  are the currents of direct and transverse damper windings,  $\Psi_{kd}$  and  $\Psi_{kq}$  are the total flux of direct and transverse damper windings,  $\Psi_{abc}$  is the stator total flux and  $\Psi_f$  is the main field total flux.

The two stator electromagnetic fields which traveling at rotor speed were identified by decomposing each stator phase current under steady-state into two components, one in phase with the electromagnetic field and other shift by  $90^\circ$ . An air-gap field with its maxima aligned to  $d$ -axis and other is aligned to the  $q$ -axis (Figure 1).

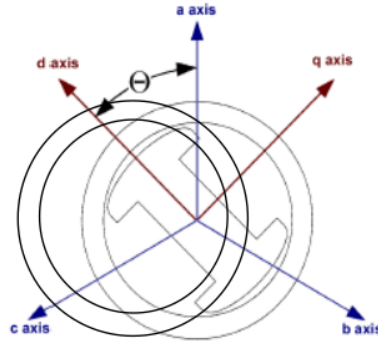

Figure 1. The generator frames,  $abc$  and  $qd0$

The differential equations of electrical dynamic that describe the stator and rotor windings are shown in (3) and are written in  $qd0$  reference of frame by utilizing Park's transformation matrix. The following relationship given by Park's transformation is:

$$i_{dq0} = P \cdot i_{abc} \quad i_{abc} = P^{-1} \cdot i_{dq0} \quad (2)$$

Where the current vectors are  $i_{dq0} = [i_0 \quad i_d \quad i_q]^T$  and  $i_{abc} = [i_a \quad i_b \quad i_c]^T$  and Park's transformation matrix is:

$$P = \sqrt{\frac{2}{3}} \begin{bmatrix} \frac{1}{\sqrt{2}} & \frac{1}{\sqrt{2}} & \frac{1}{\sqrt{2}} \\ i_a \cos \theta & i_b \cos \left( \theta - \frac{2\pi}{3} \right) & i_c \cos \left( \theta - \frac{4\pi}{3} \right) \\ i_a \sin \theta & i_b \sin \left( \theta - \frac{2\pi}{3} \right) & i_c \sin \left( \theta - \frac{4\pi}{3} \right) \end{bmatrix}$$

where  $i_a$ ,  $i_b$  and  $i_c$  are the phase currents and  $\theta$  is the angle between the phase current  $i_a$  and the current  $i_d$ .

The first three equations describe the stator winding (subscript  $s$ ) and the following three equations describe the rotor winding (superscript  $r$ ). The subscript  $k$  is used for the damping windings while the subscript  $f$  is used for the field winding.

$$\begin{aligned} v_{qs}^r &= -r_s i_{qs}^r + \frac{\omega_r}{\omega_b} \psi_{ds}^r + \frac{p}{\omega_b} \psi_{qs}^r \\ v_{ds}^r &= -r_s i_{ds}^r + \frac{\omega_r}{\omega_b} \psi_{qs}^r + \frac{p}{\omega_b} \psi_{ds}^r \\ v_{0s}^r &= -r_s i_{0s}^r + \frac{p}{\omega_h} \psi_{0s}^r & v_{kq}^r &= -r_{kq} i_{kq}^r + \frac{p}{\omega_h} \psi_{kq}^r \\ v_{kd}^r &= -r_{kd} i_{kd}^r + \frac{p}{\omega_b} \psi_{kd}^r & v_{fd}^r &= -r_{fd} i_{fd}^r + \frac{p}{\omega_b} \psi_{fd}^r \end{aligned} \quad (3)$$

In these,  $v$  represents the voltage of windings and  $i$  represents the electrical current flowing in the winding. The magnetic flux linking the winding is represented by  $\psi$ , differential operator ( $d/dt$ ) is represented by  $p$ , while  $\omega_r$  and  $\omega_b$  were angular speed of the rotor referred to a two pole generator and reference angular speed corresponded to the rated frequency, respectively.

The magnetic flux  $\psi$  for each winding is drawn in (4). The value of  $v_{kq}^r$  and  $v_{kd}^r$  are null since the damping windings are short-circuited.

$$\begin{aligned} \psi_{qs}^r &= -x_{ls} i_{qs}^r + x_{mq} (-i_{qs}^r + i_{kq}^r) \\ \psi_{ds}^r &= -x_{ls} i_{ds}^r + x_{md} (-i_{ds}^r + i_{fd}^r + i_{kd}^r) \\ \psi_{0s}^r &= -x_{ls} i_{0s}^r \\ \psi_{kq}^r &= x_{lkq} i_{kq}^r + x_{mq} (-i_{qs}^r + i_{kq}^r) \\ \psi_{kd}^r &= x_{lkd} i_{kd}^r + x_{md} (-i_{ds}^r + i_{fd}^r + i_{kd}^r) \\ \psi_{fd}^r &= x_{lfd} i_{fd}^r + x_{md} (-i_{ds}^r + i_{fd}^r + i_{kd}^r) \end{aligned} \quad (4)$$

where  $r_s$ ,  $r_{kq}$ ,  $r_{kd}$ ,  $r_{fd}$ ,  $x_{ls}$ ,  $x_{lk}$ ,  $x_{lkq}$ ,  $x_{lkd}$ ,  $x_{lfd}$ ,  $x_{mq}$  and  $x_{md}$  are the electrical fundamental parameters of synchronous generator. The direct-axis reactance  $x_d$  and the quadrature-axis reactance  $x_q$  are given by (5).

$$x_d = x_{ls} + x_{md} \quad x_q = x_{ls} + x_{mq} \quad (5)$$

The mechanical part of the generator is described by two differential equations as described in (6).

$$\begin{aligned} p\delta &= \omega_r - \omega_s \\ \frac{2H}{\omega_s} p\omega_r &= T_m - (\psi_d i_{qs} - \psi_q i_{ds}) - T_{damp} \end{aligned} \quad (6)$$

In (6),  $H$  is an inertia constant of the turbine generator set,  $T_m$  is the mechanical torque of the turbine and  $T_{damp}$  is a damping torque. The damping torque represents the

rotational losses of the rotating parts which consist of the magnetic losses and the mechanical losses.

7 Visualization of synchronous generator system block and the inside of generator block can be seen in Figure 2 and Figure 3, respectively.

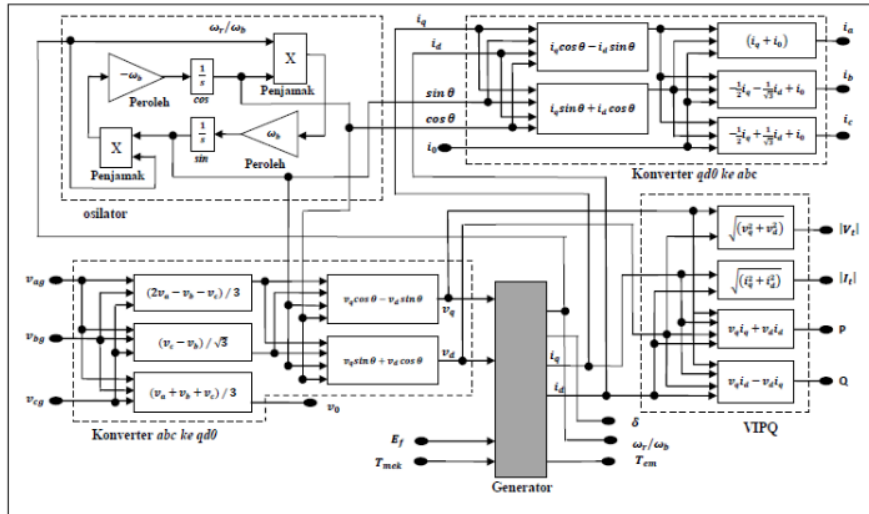

Figure 2. The model of synchronous generator

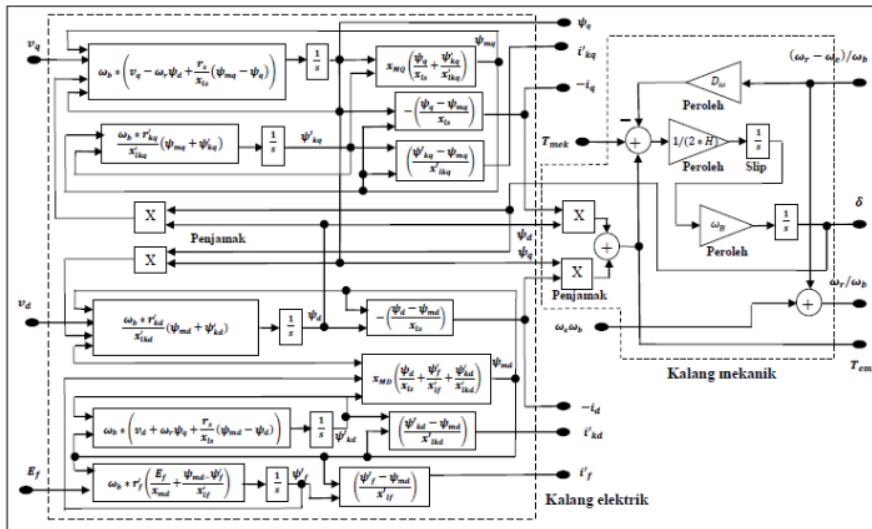

Figure 3. The inside of synchronous generator block

1 The user can access GUI facilities to develop a powerful and attractive software package for learning synchronous generator (see Figure 4). Main program is used to run the internal process which based on visualization. It consists of varies logic behind GUI and acts as a general interface between GUI and visual program. This program is also used to get or import and to send or export the physical test data. As an example of using GUI capabilities, menu and plotting commands are implemented in a script file to provide interactive windows

with varies operating conditions. The main menu, which is displayed after running the file, is shown in Figure 5 and Figure 6.

The verification of the generator model is judged through comparing between generator's respon by PSS Tecquipment NE9070 (see Figure 7) and by the proposed simulator under no load, balanced and conditions, respectively (Sugiarto *et al*, 2013) .

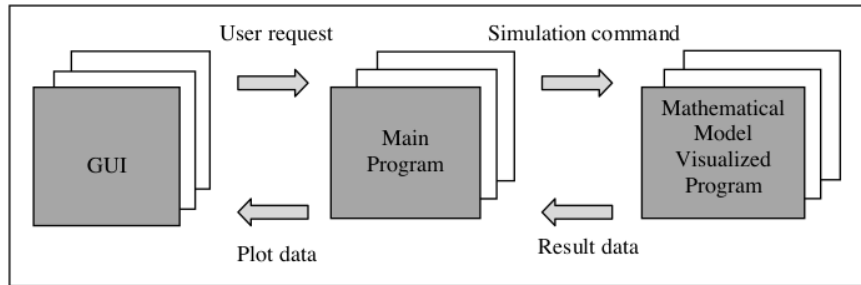

Figure 4. The configuration of synchronous generator simulator

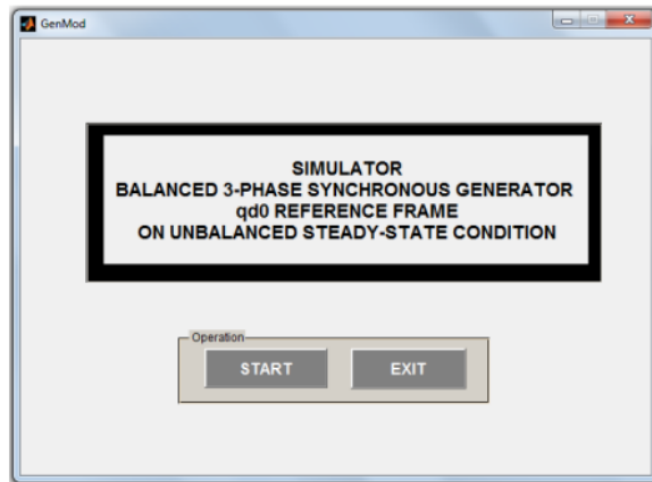

Figure 5. The main window of the developed software tool

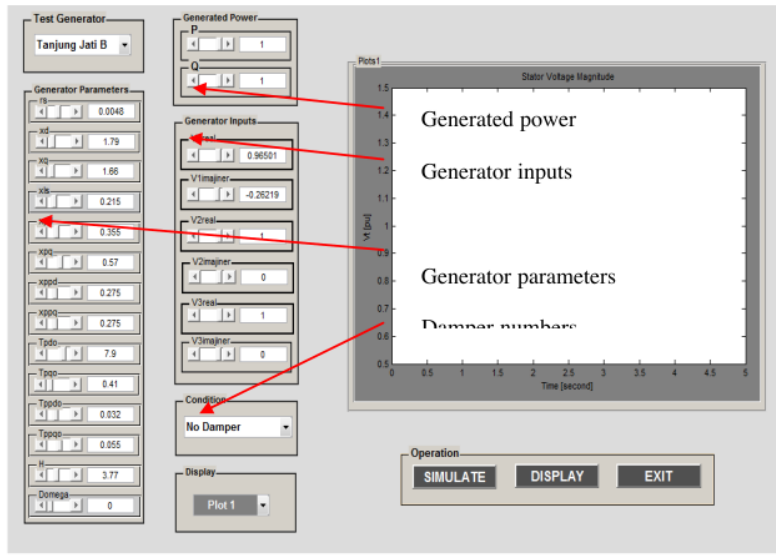

Figure 6. The window of inserting the inputs for the desired generator

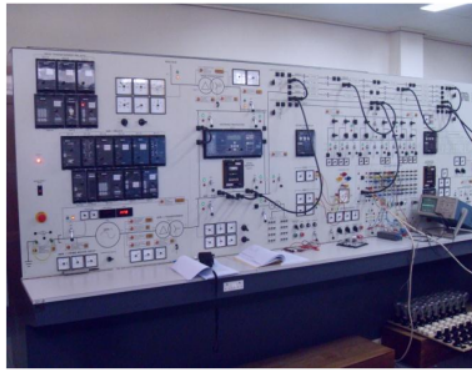

Figure 7. PSS Tecquipment NE9070

Under no load, the output respons of PSS Techquipment NE9070 are non-sinusoidal with varied excitations shown in Figure 8, eventhough the P.F value is more than 0.8. The generator's outputs are always non-sinusoidal under stand-alone operation. The waveform of it will change into sinusoidal form when the generator is connected to the grids.

The results of proposed generator's model simulation considering P.F variations are described in Figure 8. It is shown that output respons are in non-sinusoidal forms although the value of P.F excitation is reached up to 0.81. Comparing the result between Fig. 8 and Figure 9 concludes that the output respons of proposed generator model have similar trend to the output PSS Techquipment NE9070.

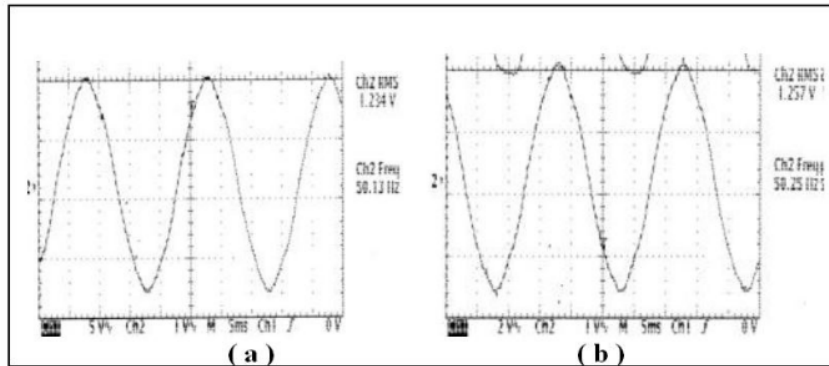

Figure 8. The output of PSS Tecquipment NE 9070 with:  
 a. 0.72 PF excitation      b. 0.81 PF excitation

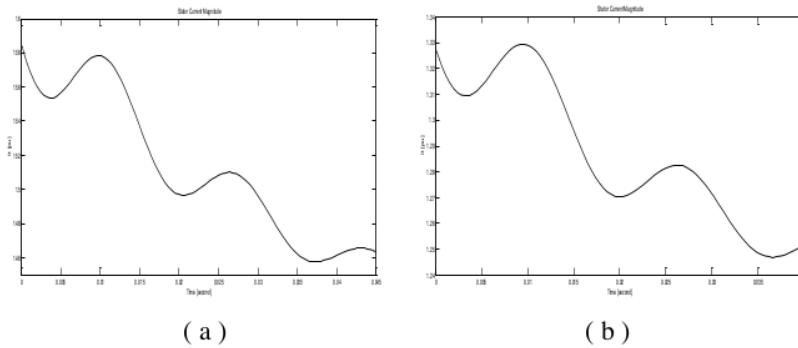

Figure 9. The output of proposed standalone generator model with:  
 a. 0.72 PF excitation.      b. 0.81 PF excitation.

Figure 10 presents the respons of PSS Techquemen NE9070. When generator is under unbalanced load condition (Figure 10.a) , its steady state respon will oscillates less than under balanced load condition (Figure 10.b). The oscillation magnitude of unbalanced load during transient condion is bigger than balanced loads counterpart.

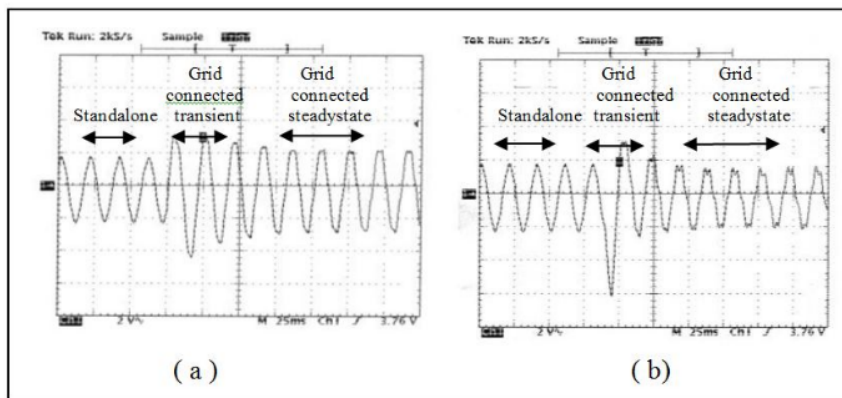

Figure 10. Outputs of the PSS Tecquipment NE 9070  
 a. Unbalanced Loads      b. Balanced Loads



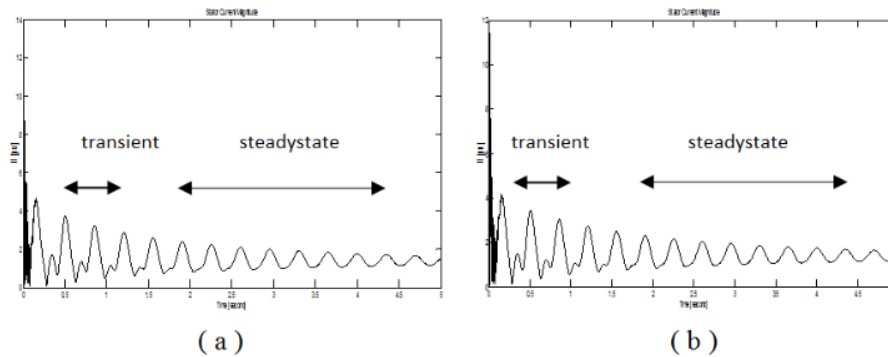

Figure 11. The outputs of the proposed generator model  
 a. Unbalanced Loads b. Balanced Loads

This condition is also occurred during simulation of the proposed synchronous model shown in Figure 11. The oscillation of stator voltage of synchronous generator during interconnecting with 7.5% unbalanced grid is bigger than it is connected to balanced grid. Conclusively, the proposed model is valid as a synchronous generator test model.

### 3. Demonstration

The simulation of the proposed generator model is carried out by visual program. As an inputs of this generator model, which are stator voltages, is derived by giving an arbitrary values. The process of numerical simulation method can be presented by the block diagram of Figure 12.

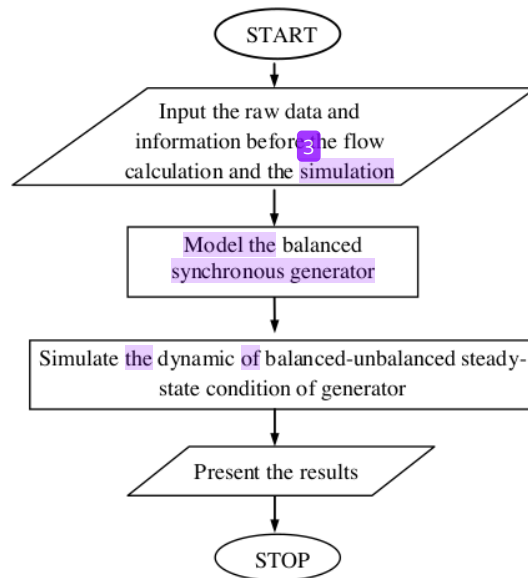

Figure 12. Simulation flowchart

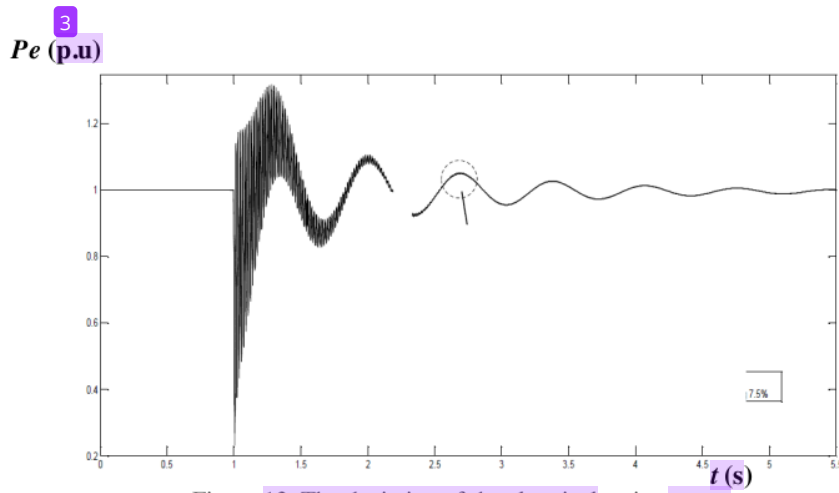

Figure 13. The deviation of the electrical active power.

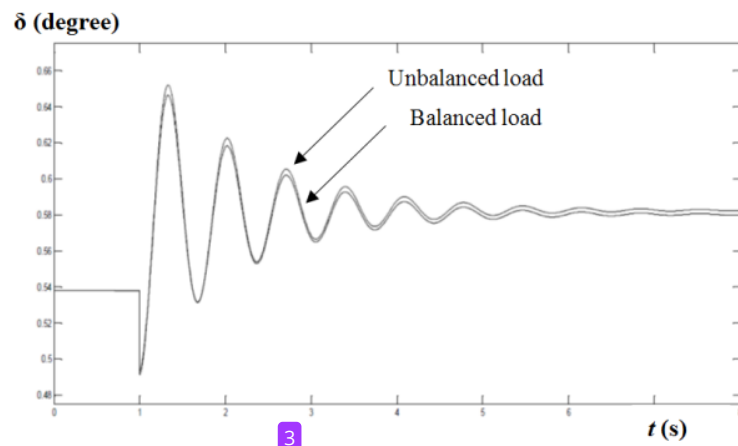

Figure 14. The deviation of the rotor angle

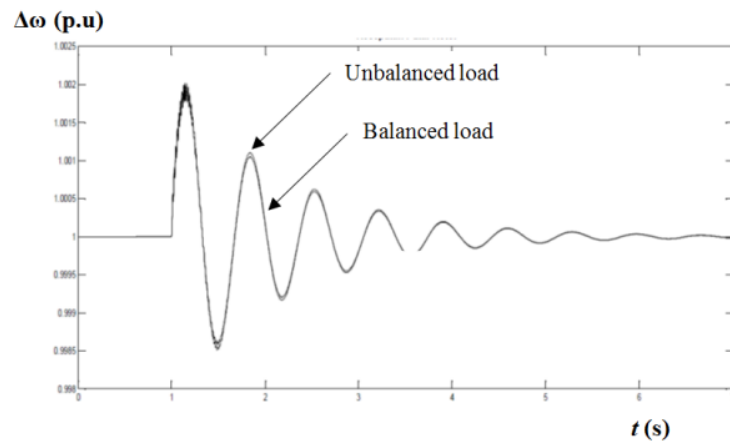

Figure 15. The deviation of the angular speed

#### 4. Conclusion

A useful approach for learning a three-phase synchronous generator under steady-state operation has been presented in this paper. Two operation conditions of the synchronous generator, such as balanced and unbalanced loads, are mathematically modeled then simulated using visual program. The designed tool is made easy to use by providing an active link with the simulated models using some of GUI function. The given examples demonstrate helpfulness of the designed tool for learning the generator dynamic under steady-state operation.

#### References

- [1] Ching, Y.K., Adkins, B., 1953, *Transient Theory of Synchronous Generators under Unbalanced Conditions*, Institution Monograph, Supply Section, No. 85, 15th December.
- [2] D.D. Robb, P.C. Krause, 1975, *Dynamic Simulation of Generator Fault Using Combined abc and Odq Variables*, IEEE Transaction on Power Apparatus and System, Vol. PAS-94, no. 6.
- [3] J. van Amerongen, P.J. Buys, H.W.M. Barends, G. Honderd, 1984, *Modelling and Control a 180-MW Power System*, Proceedings of 23rd Conference on Decision and Control, Las Vegas, NV.
- [4] Suni, J.C.P., Ruppert, E., Fajoni, F., 2010, *A Guide for Synchronous Generator Parameters Determination Using Dynamic Simulations Based on IEEE Standards*, Rome, XIX International Conference on Electrical Machine – ICEM.
- [5] Sugiarto, Hadi, S. P, Tumiran, Wijaya, F. D., 2013, *Teaching the Large Synchronous Generator Dynamic Model under Unbalanced Steady-State Operation*, Proceedings of 2013 International Conference on Information Technology and Electrical Engineering, (ICITEE 2013), Yogyakarta, Indonesia.

# Dynamic Modeling And Simulation Of The Synchronous Generator

---

ORIGINALITY REPORT

---

20%

SIMILARITY INDEX

---

## PRIMARY SOURCES

---

- 1 [journals.sagepub.com](http://journals.sagepub.com)  
Internet 112 words — 7%

---
- 2 [www.waset.org](http://www.waset.org)  
Internet 33 words — 2%

---
- 3 A. Demiroren, H. L. Zeynelgil. "Modelling and Simulation of Synchronous Machine Transient Analysis Using Simulink", The International Journal of Electrical Engineering & Education, 2012  
Crossref 30 words — 2%

---
- 4 Ranjan Vepa. "Dynamic Modeling, Simulation and Control of Energy Generation", Springer Science and Business Media LLC, 2013  
Crossref 28 words — 2%

---
- 5 S. Ranjith Kumar, P. Raja, M.P. Selvan. "Virtual laboratory environment using MATLAB-GUI for teaching of induction generators", 2012 Annual IEEE India Conference (INDICON), 2012  
Crossref 24 words — 1%

---
- 6 [www.rroij.com](http://www.rroij.com)  
Internet 23 words — 1%

---
- 7 [www.thieme-connect.com](http://www.thieme-connect.com)  
Internet

14 words — 1%

8 Kalpesh Dange, Tejas Barhate, Dipti Malaye, Sanket Narwade, R. D. Kulkarni, K. Vadirajacharya. "Design and modeling of low power alternator for solar thermal application", 2017 International Conference on Nascent Technologies in Engineering (ICNTE), 2017

Crossref

9 Yaser N. Anagreh, Imadden M. Al-Refae'e. "Teaching the Self-Excited Induction Generator Using Matlab", The International Journal of Electrical Engineering & Education, 2012

Crossref

10 Kyriakides, E.. "Estimation of synchronous generator parameters using an observer for damper currents and a graphical user interface", Electric Power Systems Research, 200404

Crossref

11 ijeee.iust.ac.ir

Internet

12 H. Tsai, A. Keyhani, J. Demcko, R.G. Farmer. "On-line synchronous machine parameter estimation from small disturbance operating data", IEEE Transactions on Energy Conversion, 1995

Crossref

13 Daru Sugati, Indarto, Purnomo, Sutrisno, Marwan Effendy, Eka Yawara. "Identification performance of the liquid-gas ejector using static pressure distribution", AIP Publishing, 2018

Crossref

---

14

epdf.pub

Internet

8 words — < 1%

---

15

Wagner Eduardo Vanço. "Análise das perturbações causadas pela poluição harmônica e por desequilíbrio de tensão em geradores síncronos de polos salientes isolados", Universidade de Sao Paulo, Agencia USP de Gestao da Informacao Academica (AGUIA), 2020

6 words — < 1%

Crossref Posted Content

---

EXCLUDE QUOTES ON

EXCLUDE MATCHES OFF

EXCLUDE BIBLIOGRAPHY ON